



mxmóveis

Rodovia SC-492 - Km 10 - B. Industrial

89905-000 - Bandeirante - SC

Fone: (49) 3622-4549

e-mail: mxmoveis@mxmoveis.com.br

Ref. MU001

Ref. MU001.NE

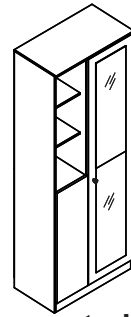
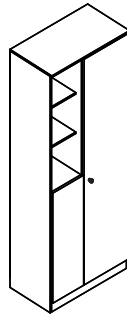

Sapateira
Mueble para zapato
Furniture for shoes

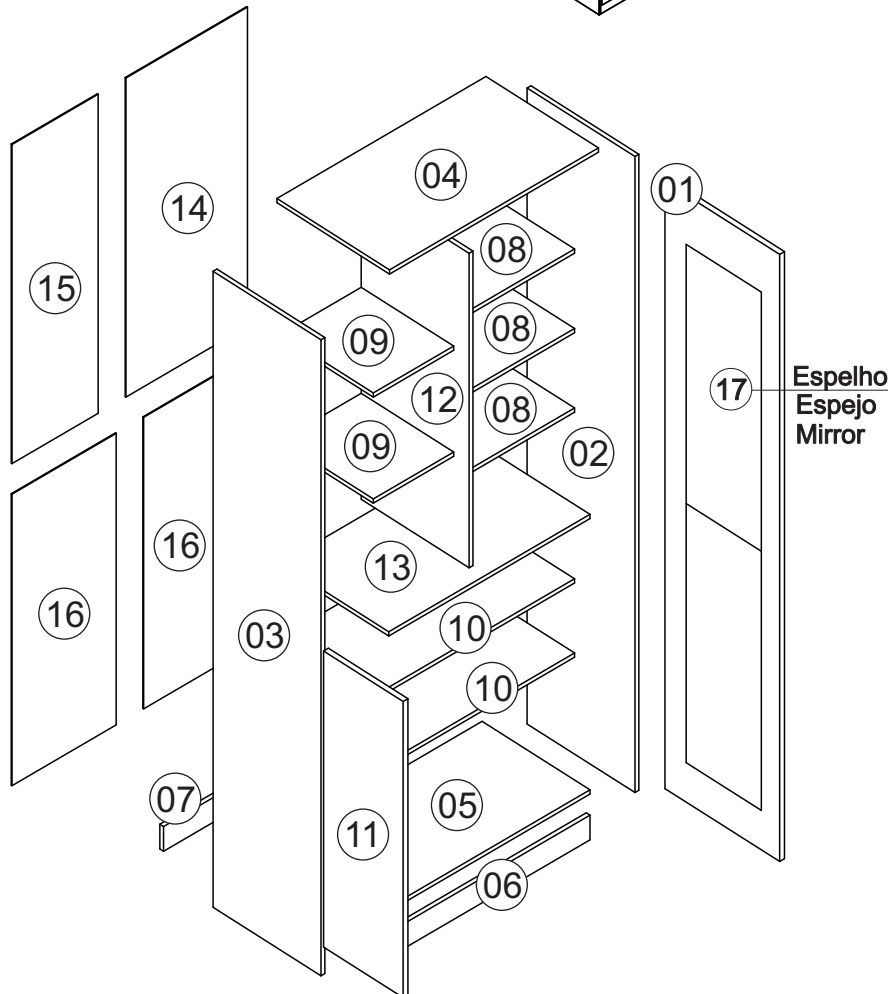

Nº	CÓDIGO CODE ASSISTÊNCIA ATTENDANCE	NOME DA PEÇA/DESCRIPCIÓN PIEZAS/DESCRIPTION PARTS	MEDIDAS (mm) MEASURES (mm)	QTD.	HAVANA/ HAVANA RIP.	TERRANO/ TERRANO RIP.	MARROCOS MARROCOS	MARROCOS MARROCOS RIPADO	BRANCO
01	MU001.25.00	Porta/Puerta/Door	1722x373x15	01	54306	54295	189468	280337	54229
02	MU001.17.00	Lateral externa direita/Lateral derecha/Right side	1800x350x12	01	152383	54638	189469	189469	54501
03	MU001.18.00	Lateral externa esquerda/Lateral izquierda/Left side	1800x350x12	01	152384	58761	189470	189470	58755
04	MU001.05.00	Base superior/Base superior/Shelf	650x365x12	01	168824	168823	189472	189472	168822
05	MU001.01.00	Base Inferior/Base/Shelf	626x350x12	01	54511	54496	189473	189473	54504
06	MU001.30.02	Rodapé frontal/Zócalo delantero/Front footer	626x70x12	01	54312	49370	189474	189474	54235
07	MU001.32.00	Rodapé traseiro/Zócalo de atrás/Rear plinth	626x70x12	01	45477	45477	45477	45477	45477
08	MU001.27.02	Prateleira/Plateler/Silversmith	364x300x12	03	54497	54497	54497	54497	54497
09	MU001.27.01	Prateleira/Plateler/Silversmith	250x300x12	02	58763	58759	189475	189475	58756
10	MU001.27.00	Prateleira/Plateler/Silversmith	626x300x12	02	54498	54498	54498	54498	54498
11	MU001.25.01	Porta/Puerta/Door	840x260x15	01	54305	54294	189467	280336	54228
12	MU001.19.00	Lateral interna/Lateral interna/Inner side	890x350x12	01	54509	54494	189471	189471	54502
13	MU001.02.01	Base interna/Base interna/Interna base	626x350x12	01	58764	58760	189476	189476	58757
14	MU001.13.00	Forro/Revés/botton	903x378x2,5	01	51000	51000	51000	51000	51000
15	MU001.13.02	Forro/Revés/botton	903x268x2,5	01	60777	60763	189477	189477	60743
16	MU001.13.01	Forro/Revés/botton	830x323x2,5	02	51002	51002	51002	51002	51002
17	4861	Espelho/Espejo/ Mirror	800x250	02	-	-	-	-	-

Ferragens/Herrajes/Hardware

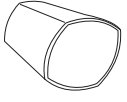
A  **01x**
Cód. 7759
Puxador/Manija/Puller

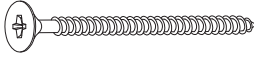
B  **20x**
Cód. 691
Parafuso/Tornillo/Screw 3.5x40mm Cht.

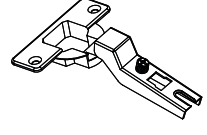
C  **05x**
Cód. 10269
Dobradiça/Visagra/Metal hinge

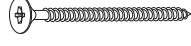
D  **01x**
Cód. 794
Parafuso/Tornillo/Screw 3.5x30mm Cht.

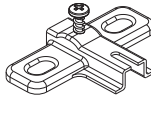
E  **05x**
Cód. 12539
Calço dobradiça/Calzo de visagra/ Chock to hinge

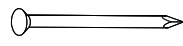
F  **65x**
Cód. 822
Prego/Clavo/Nail

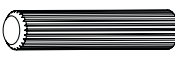
G  **04x**
Cód. 873
Cavilha/Clavija/Peg Ø 6,0x30mm

H  **04x**
Cód. 800
Sapata/Zapata/Shoes

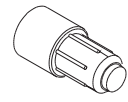
I  **28x**
Cód. 790
Suporte plastico/Soporte plastisco/ plastic support

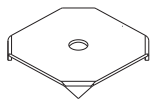
J  **09x**
Cód. 7169
Fixador costa/Fijador de orilla/ Shore Fixer

K  **01x**
Cód. 2059
Perfil plástico/plastic profile 825mm

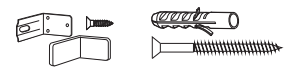
L  **01x**
Cód. 754
Kit aereo/Kit aerio/Air kit

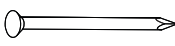

M  **04x**
Cód. 821
Prego/Clavo/Nail

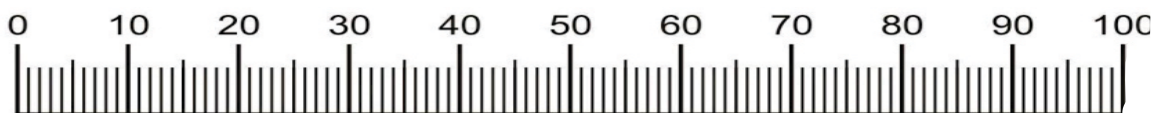

N  **20x**
Cód. 7604
Parafuso/Tornillo/Screw 4,0x12mm Cht.

O  **01x**
Cód. 8255
Bisnaga cola/tubo de pegamento/glue tube

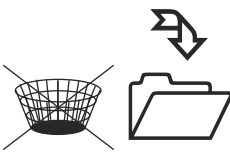
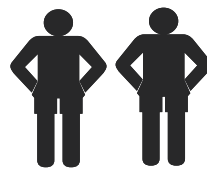

Medidas em mm
Measures in mm
Meduras en mm

- | | |
|---|---|
|  | Produto para ser aplicado em caso de riscos na superfície. |
|  | Product to be applied in case of scratches on the surface. |
|  | Producto para ser aplicado en caso de rayas en la superficie. |

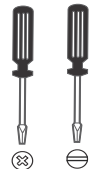
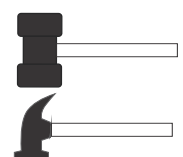
		 1:00		
---	---	--	---	---

Pré-Montagem/Preparación Piezas/ Pre-assembly

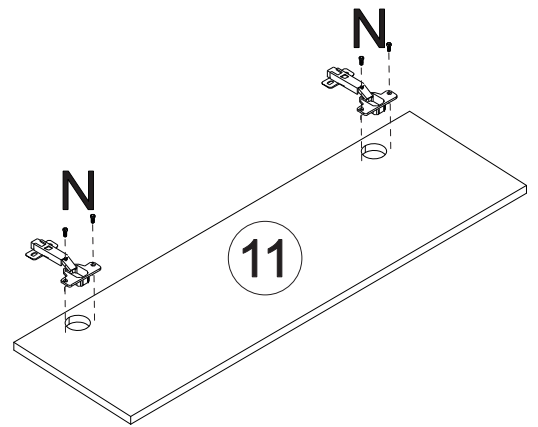
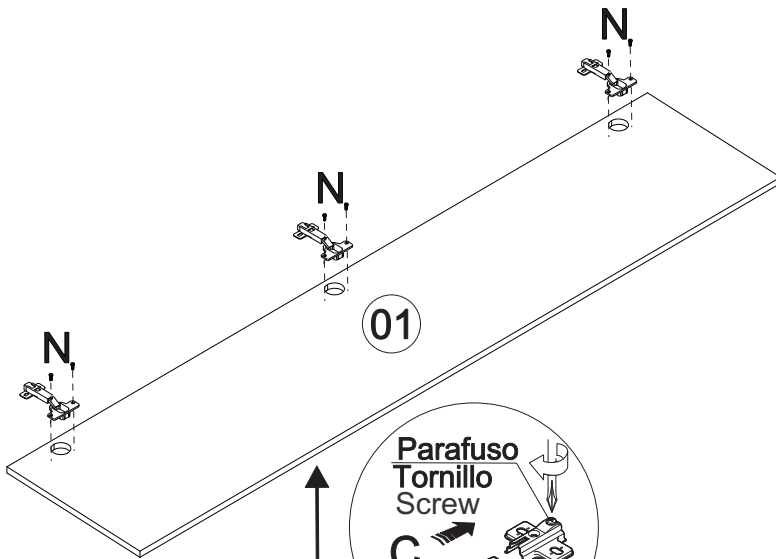

*Usar uma proteção
no chão para não
danificar o espelho

*Utilizar una protección
en el suelo para no
dañar el espejo

*Use a floor guard to avoid
damaging the mirror.

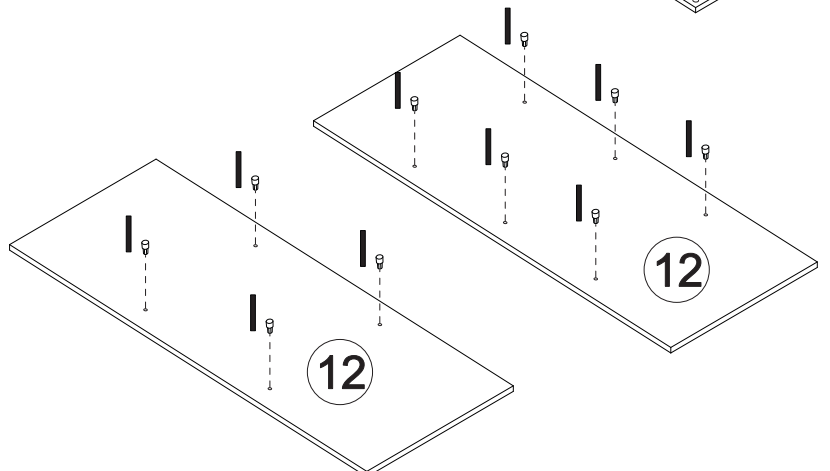
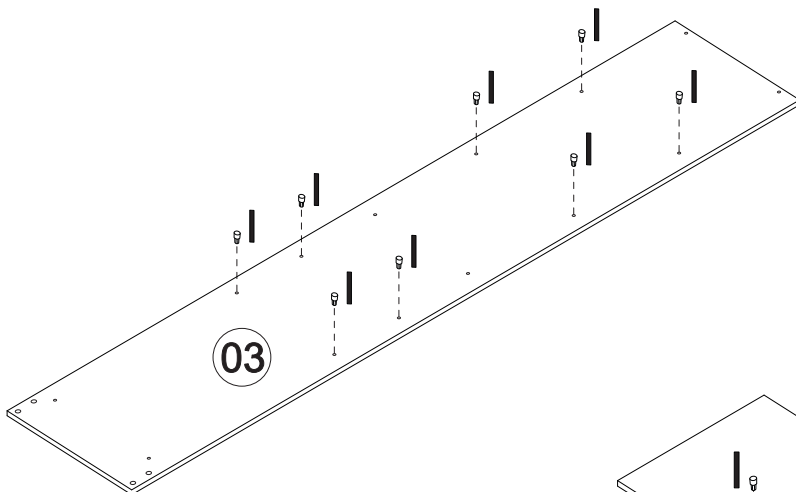
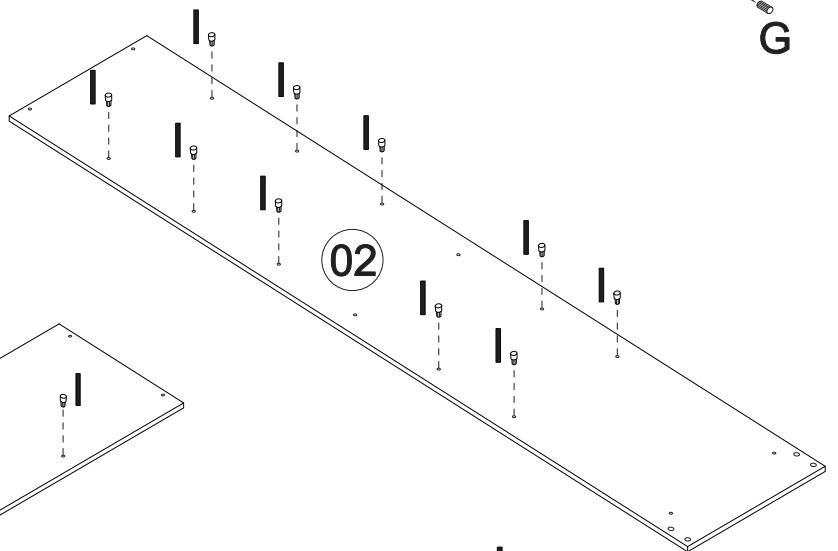
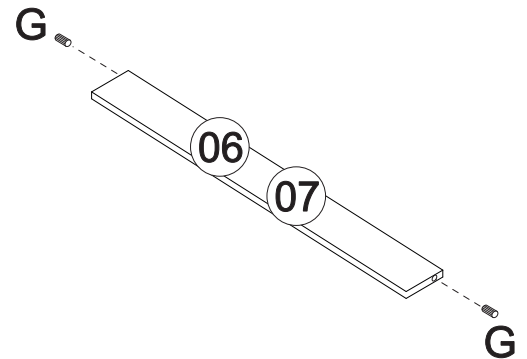

01 Montagem/Montaje/Assembly

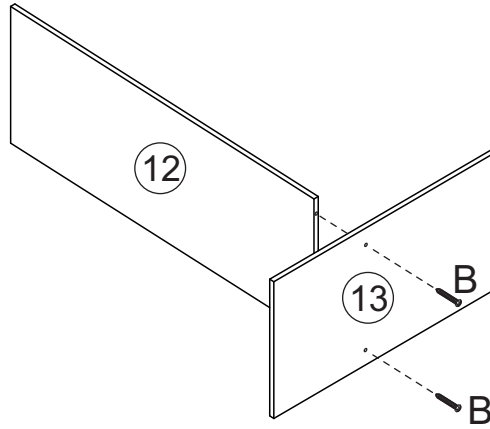

02

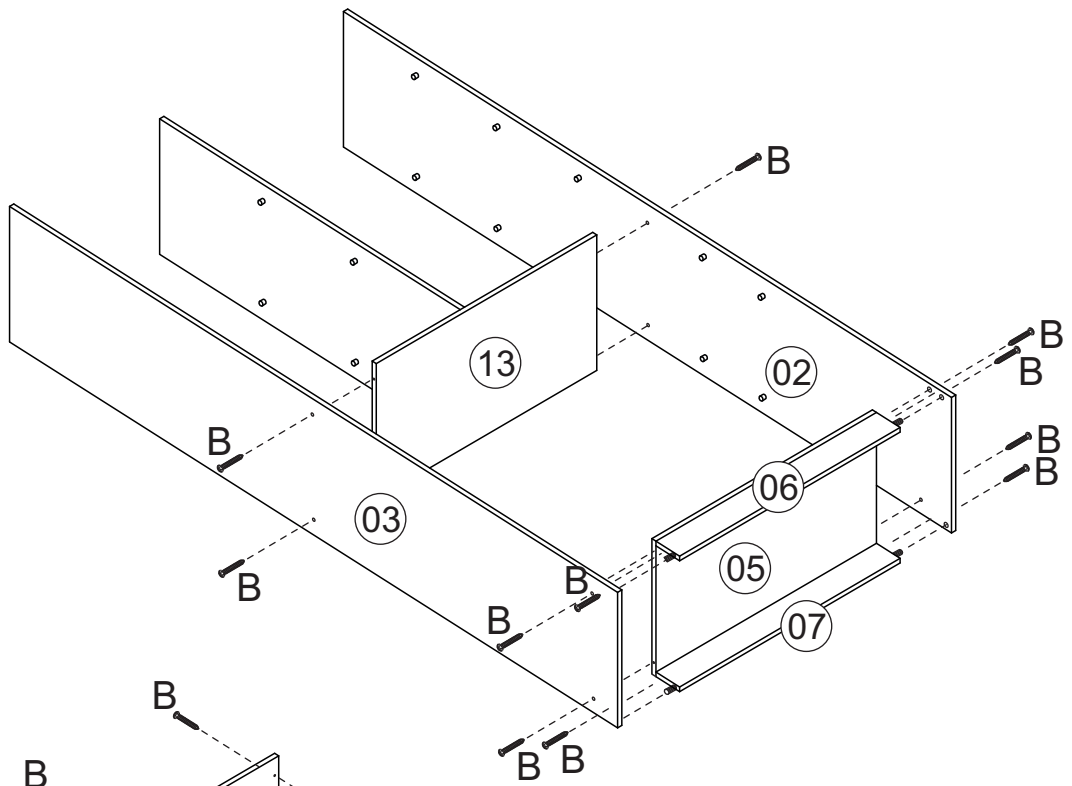

03

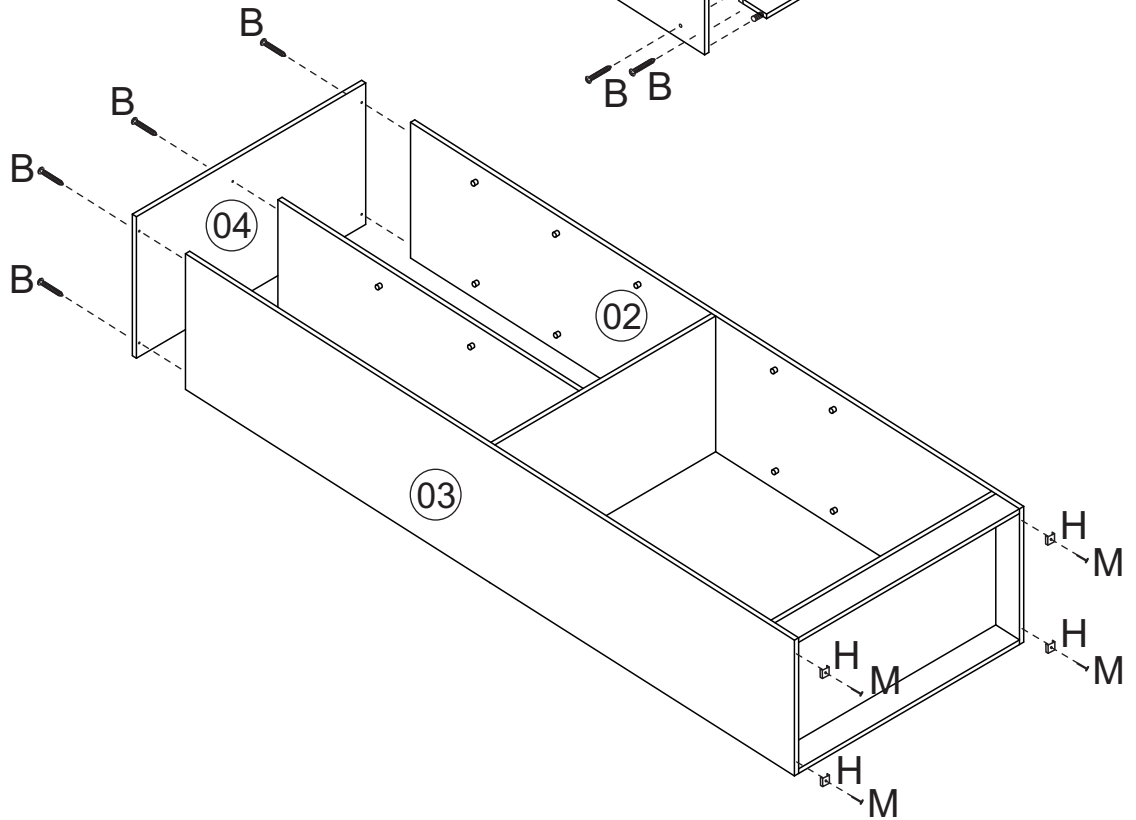

04 Montagem/Montaje/Assembly

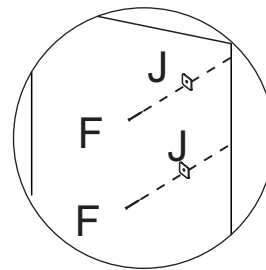
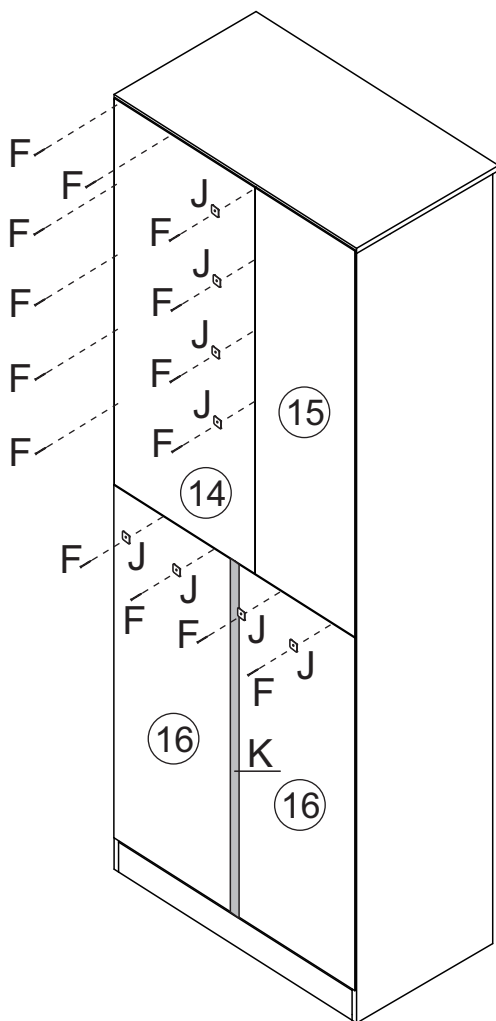

*Usar o prego (F) e a junção (J) a cada 150mm
 *Usar el clavo (F) y la junta (J) cada 150mm
 *Use the nail (F) and the joint (J) every 150mm

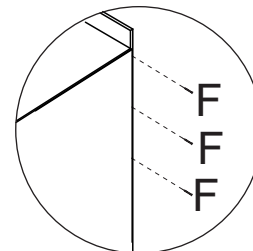

*Colocar um prego (F) a cada 100mm
 *Colocar un clavo cada (F) 100mm
 *Place a nail every (F) 100mm

05

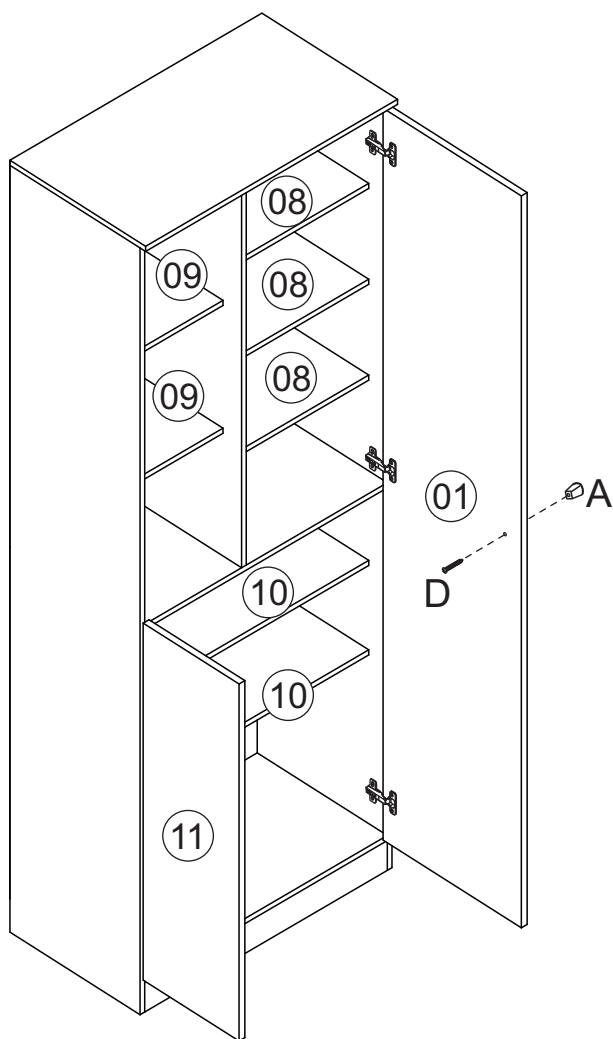
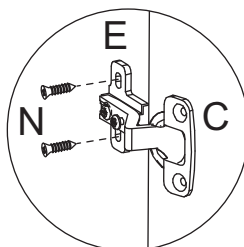

Fixação na parede
 Fijación en la pared
 Wall mounting

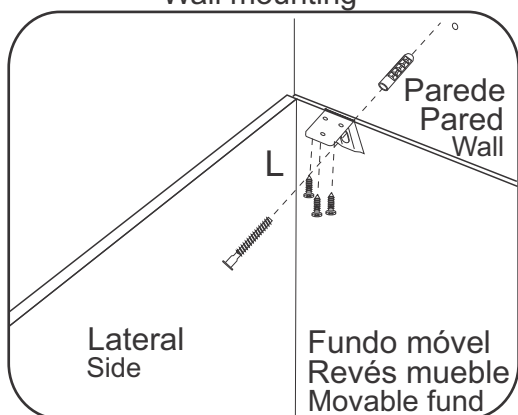

*Fixar a cantoneira na parte interna do móvel.
 Fijar la pieza «L» en el interior del mueble.
 Attach an angle bracket to the inside of the furniture.

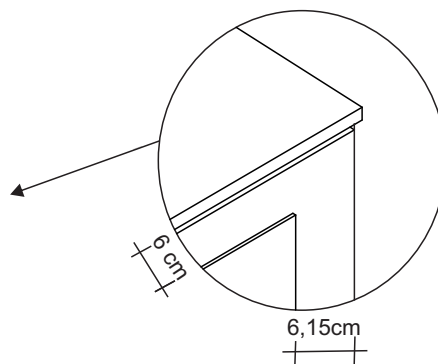
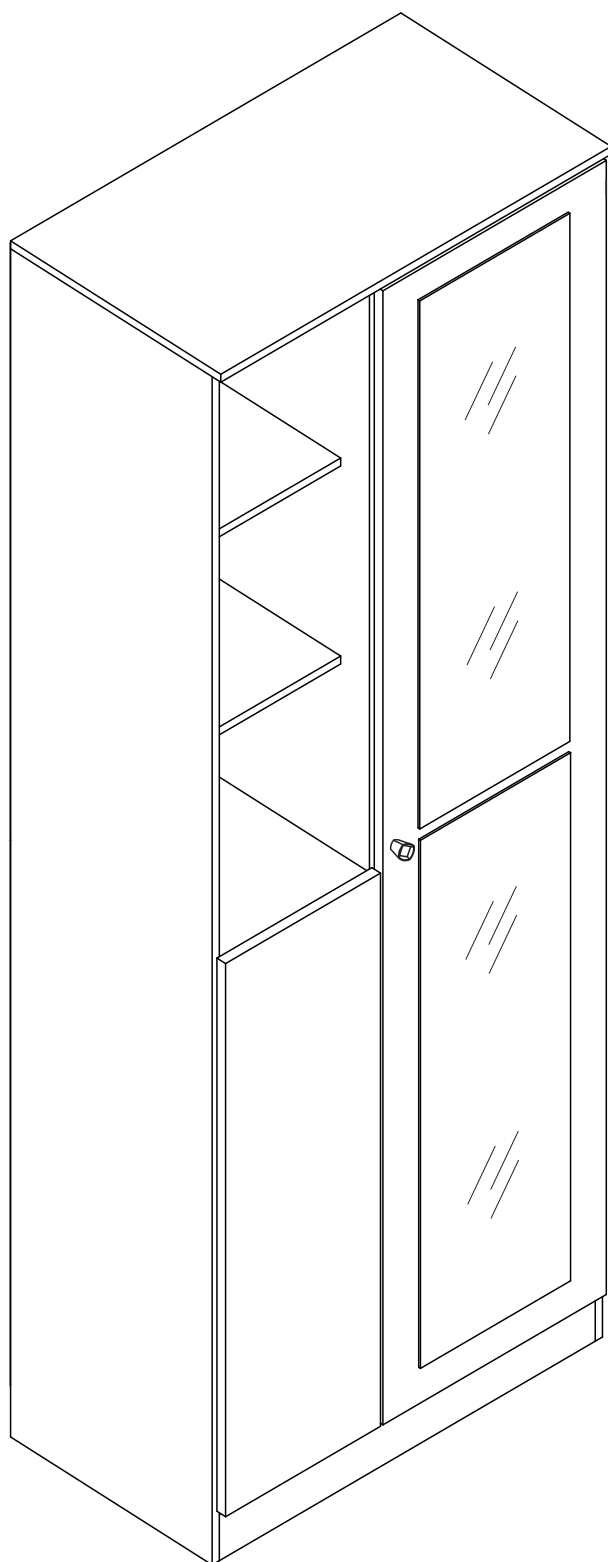

-(VERIFICAR SE O ESPELHO ESTA BEM FIXADO, CASO FOR NECESSÁRIO, AJUSTAR O MESMO).
-(CONSULTAR SI EL ESPEJO ES FIJO, SI ES NECESARIO AJUSTARLO).
-(CHECK IF THE MIRROR IS FIXED, IF NECESSARY, ADJUST IT).

Limpeza/Limpieza

- ☞ Use um pano levemente umedecido com água, seguido de pano seco.
- ☞ Use solamente un paño húmedo con agua y después un paño seco.
- ☞ Use a cloth slightly dampened with water, followed by a dry cloth.
- ☞ Nunca utilize produtos químicos ou abrasivos.
- ☞ No utilice productos químicos o abrasivos.
- ☞ Never use chemical or abrasive products.